



In Situ Gamma Spectroscopy with ISOCS™, an *In Situ* Object Counting System

Practical *In Situ* Gamma Spectroscopy

In situ Gamma spectroscopy is not new, but with the improvements in ISOCS, it is now a practical field tool to solve today's problems. And here's why:

- **Germanium detectors** offer stability and high resolution that cannot be obtained with NaI detectors.
- **Large Ge detectors** are now very common and affordable, and give excellent sensitivity with short counting times.

Our new BEGe detectors are especially well suited for *in situ* measurements where enhanced low energy MDAs are important along with good high energy performance.

- **The Canberra™ MAC [Multi-Attitude Cryostat]** allows the detector to point in all directions and allows 2 day LN holding time. The **Big MAC** has a 5 day holding time.
- **The InSpector™ 2000 MCA** with digital signal processing, when combined with a laptop PC gives laboratory quality gamma spectral acquisition, in a portable battery operated package.
- **Genie™ 2000** gamma spectroscopy data analysis package offers automatic and reliable spectral analysis.
- **The new ISOCS Shield package** ties all of the hardware together, and makes it portable.
- **The new ISOCS Calibration Software*** performs high quality efficiency calibrations for most all geometries without ANY radioactive sources.



Typical ISOCS Applications

With its "go anywhere, count anything" detector and shield, battery powered electronics, and unique calibration software, ISOCS can be used in a wide variety of *in situ* assay applications. Here are a few of the more common uses; for a more comprehensive list, see page 10.

Decontamination Assessment

Determination of near-surface ground contamination.
Determination of subsurface contamination by "well logging".

Building Contamination Assessment

Wall, floor, and/or ceiling activity measurements. Pipe and duct holdup measurements. Assessment of status of decontamination efforts.

Radioactive Waste Measurements

Measurement of nuclides and activity of boxes, bags, drums, and other objects. Free release measurements.

Environmental Monitoring

Determination of site natural background. Deposition following real or suspected accidents. Field assay of air particulate and iodine cartridges.

Public Health Measurements

Immediate results from the measurement of suspected contaminated areas.

Health Physics Measurements

Total room contamination [walls, ceilings, non-removable fixtures]. Determination of the cause for abnormal gross/doserate survey indications. Free-release determination of objects.

Nuclear Facility Maintenance

Identify nuclides in pipes or tanks *without* opening them. Quantify hard to sample residual activity from plateout.

Emergency Response Teams

Immediate answers to questions like "What and how much has spilled?", "What set off the gross counter alarm?", and "Is that wound contaminated?"

*Patent Pending



The ISOCS Detector, Cart, and Shield Components.

Configured for Soil/Floor Analysis.

Configured for Samples in Small Containers.

Can also Count Large Samples in Marinelli Beakers.

Figure 1

The versatile ISOCS Detector Holder and Shield can be positioned and configured to handle most any sample geometry.

Regulatory Authorities & Inspectors

Analyze split or duplicate samples with licensee, compare results of sampling vs. total object measurement.

The Benefits of ISOCS in D&D/ER Applications

Consider the problem of contaminated buildings and grounds. The three most expensive items in the decommissioning of buildings or grounds that are radiologically contaminated are:

1. The labor for the decontamination assessment,
2. The labor for the actual decontamination, and
3. The cost of disposing of the radioactive waste.

The time and labor cost needed to survey and assess a site can be greatly reduced by *in situ* assay because it:

- Eliminates the loop of field sampling, laboratory assay, more field sampling.
- Readily separates contaminants from naturally occurring radionuclides with high resolution Ge gamma spectroscopy.

- Provides essentially instantaneous qualitative and quantitative results that can be used to optimize the measurement and decontamination process.

In addition, since the inherent sampling errors associated with the sampling of non-homogeneous materials are minimized, you get both lower costs and better results.

The improved accuracy of *in situ* assay reduces these costs by minimizing the volume of waste that must be removed. This means that both the labor needed to decontaminate the site *and* the cost of waste disposal are greatly reduced.

The ISOCS System

An ISOCS system consists of the following major components:

1. An "ISOCS Characterized" Germanium Detector
2. A versatile set of Shields and Collimators on a Cart.
3. An InSpector 2000 Portable Spectroscopy Workstation.
4. An IBM-compatible Laptop PC running Genie 2000 software.
5. ISOCS *In Situ* Calibration Software.

A brief description of each of these can be found in the sections which follow.

The ISOCS Detector and Shield

The detector, shield system, and mounting cart, shown in Figure 1, are key elements to the unique versatility of ISOCS.

The Detector

While the typical ISOCS detector will be a coaxial Germanium with a relative efficiency of 30-80%, the design of the shield allows selecting the type – including Broad Energy (BEGe), Low Energy (LEGe) and Reverse Electrode (REGe) detectors – and size best suited to the specific needs of the intended application.

The most versatile detector is our new BEGe detector, which give the highest efficiency at low energies, while still retaining excellent performance at high energies.

For greatest flexibility, the detector should be mounted in a remote detector chamber (RDC) cryostat and be equipped with a MAC or Big MAC Dewar. These Dewars have the ability for the detector to be operated at any attitude or angle with no LN spillage or reduction in LN capacity.

The RDC allows the back-shield to be used, reducing interfering radiation. The MAC is smaller and has a two day LN holding time, while the Big MAC is the most common choice since it has a five day holding time.

Once a detector is selected, it is fully characterized using a combination of source measurements and MCNP calculations. The results of this characterization are then utilized by the ISOCS calibration software, as described on page 4.

The Shield

The complete shield package includes both 2.5 cm (1 inch) and 5 cm (2 inch) lead shield assemblies.

Each features:

- Modular design for ease of handling and reconfiguration.
- Cast aluminum exterior with baked epoxy coating to simplify decontamination.
- 30°, 90°, and 180° collimator assemblies to minimize interfering radiation and limit the field of view.
- 0° shield for background measurements, and to make the shield into a closed sample counting chamber.
- Back shield for use with RDC detectors to reduce interfering radiation from the behind the detector.

In addition, as shown in Figure 1 and in Figure 14 on page 9, the two shield sizes may be combined into a single shielded counting chamber for field assay of small packaged samples.

The Cart

The cart to which the detector and shield assembly are mounted is used for both moving the ISOCS system around the site, and as a mounting base when it is being used for sample assay.

As shown in Figure 1, the cart provides both the normal lower mounting position for the detector/shield, and an upper position for one meter *in situ* ground counting. It is very



Figure 2
The InInspector 2000 MCA with its Laptop Control and Analysis Computer and Germanium Detector in a Big MAC Cryostat.

easy to move the detector and shield between the two positions.

The pivoting detector-holder mechanism provides the ability to easily rotate the detector and shield to ANY desired angle at either of the vertical positions, allowing the detector to be quickly “aimed” at objects of essentially any size, shape, or location.

The detector holder also includes a battery operated laser aiming device to aid in accurately aligning the detector with the object being assayed. This is particularly useful for samples at some distance from the detector, such as overhead pipes.

The InInspector 2000 Portable Spectroscopy Workstation

The battery-powered Digital Signal Processor allows laboratory quality measurements in the unfriendly temperature extremes and wide dynamic count rate ranges commonly encountered by *in situ* users. The Canberra InInspector 2000 MCA, mated to an IBM compatible notebook PC, serves as the spectroscopy workstation for ISOCS (Figure 2).

For *in situ* assays it offers several major benefits:

- Lightweight compact design.
- Long operating life [full work day] on a single battery.
- Complete laboratory grade digital signal processing spectroscopy front end:
 - Detector HVPS.
 - Signal gain.
 - Digital gain and zero stabilization.
 - 16,384 channel ADC and memory.
 - Digital oscilloscope for accurate pole zero adjustment
- Computer control of all operating parameters, insuring maximum accuracy with a minimum of effort on the part of the operator.

The net result is uncompromising spectroscopy quality in a small, lightweight package ideally suited to field use.

Genie 2000 Software

The laptop PC which controls the system is under the supervision of the Genie 2000 software package. With it, all of the capabilities of a laboratory based spectroscopy system – including the Gamma Acquisition and Analysis Window and all Gamma Analysis applications – are available for the *in situ* user.

On top of this, the user can add PROcount, a simple fill-in-the-blank counting procedure package for performing routine ISOCS operations. Using PROcount's step-by-step procedures, the operator is shielded from the intricacies of the computer, allowing full concentration on the job at hand (Figure 3). This insures more consistent results and greatly reduces the opportunity for procedural errors.

While PROcount makes ISOCS easier to use, it in no way limits the system's capabilities. Standard PROcount procedures are provided for all needed system operations, including:

- Routine Sample Assays.
- Background Counts.
- Energy and Efficiency Calibrations.
- System Quality Assurance.

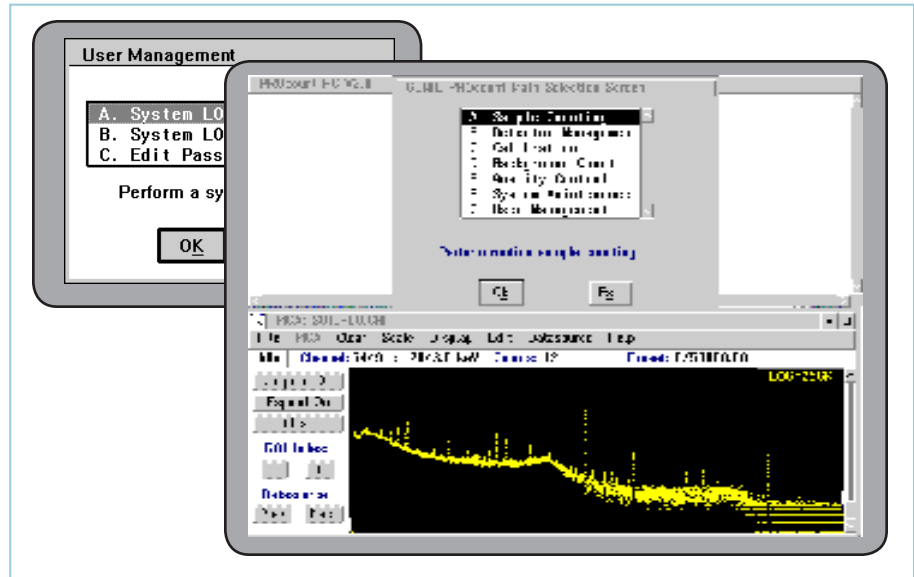

Figure 3
The Genie-PC with PROcount leads you through all assays with simple menus and fill-in-the-blank screens.

There is also a password-protected facility for customizing these standard procedures, defining new sample types and geometries, setting up special sample information data entry screens, and building custom analysis sequences and reports.

ISOCS Calibration Software

Accurate efficiency calibration is a must for any system being used for sample assay. Traditionally this has meant a major investment in the purchase (and later disposal) of a variety of calibration sources plus days of calibration time and effort. And each time a new geometry

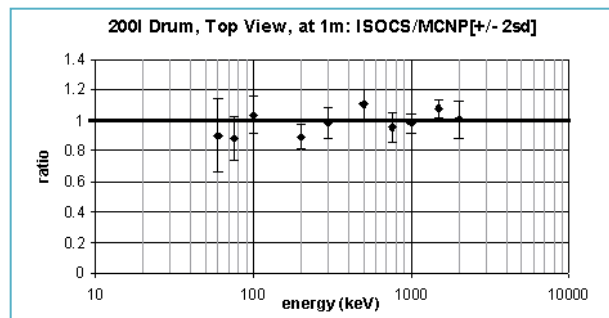
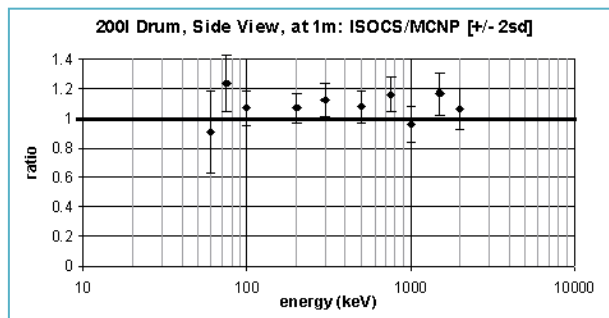
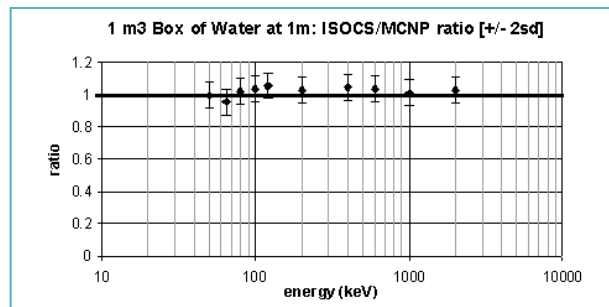
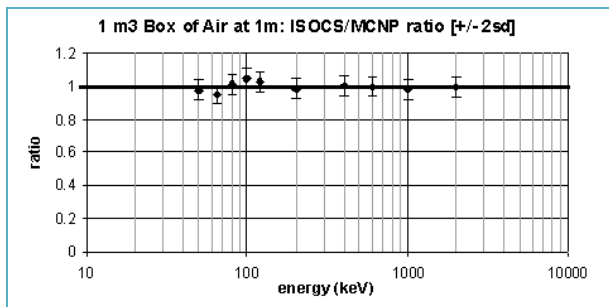

Figure 4
ISOCS and traditional efficiency calibrations typically agree within a few percent.

was encountered, a new calibration standard had to be prepared and new calibration runs performed. As you can see in Figure 4, with ISOCS and its unique calibration method you get the accuracy you need without this expense and effort.

The calibration of an ISOCS system is a three step process:

1. Determining the response function of each specific Ge detector, i.e. detector characterization.
2. Creating a series of basic sample templates to cover the range of samples to be measured.
3. Selecting the detector, the collimator, and the template, and entering the parameters to describe the object.

Detector Characterization

This is done by us, using a few NIST-traceable sources and the well-known MCNP Monte Carlo modeling code. Specifically, the radiation response profile of each individual detector is determined for a 1000 meter diameter sphere around the detector over a 45 keV through 7 MeV energy range. The results of this characterization are delivered to the user in the ISOCS software. When multiple detectors are characterized, all are available for selection by the ISOCS user.

Geometry Template Definition

This is also done by us. Currently, ISOCS has ten standard geometry templates (see page 5) plus an additional set of special surface contamination templates for D&D applications. Additional templates will be made available as they are developed. If these very flexible standard templates aren't adequate for your application, custom templates can be created.

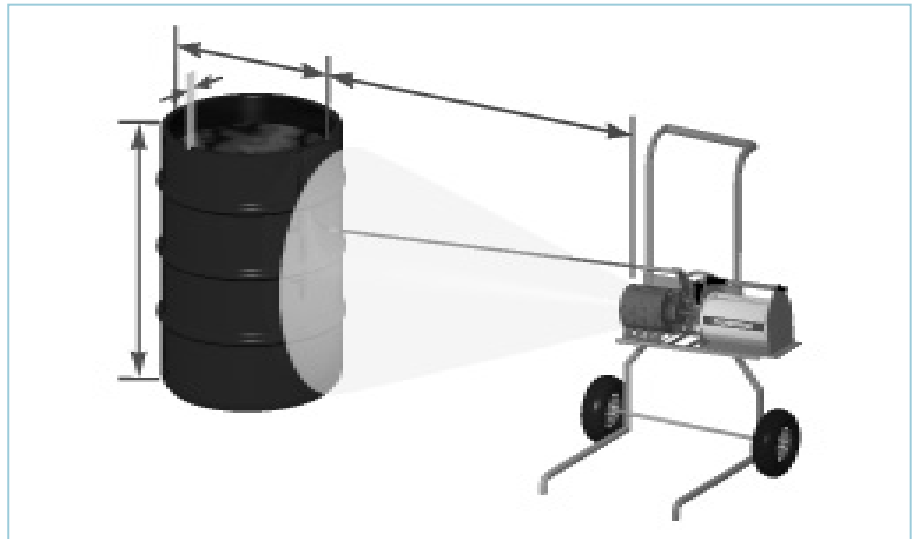

Figure 5

This is typical of the types of sample dimensions required by the ISOCS calibration software.

Parameter Entry

The easy part is performed by the user. By simply making a few physical measurements of the sample and entering them into the appropriate ISOCS calibration template, the source-detector geometry is defined. As shown in Figure 5, these measurements include things like the dimensions of the sample, the type and density of the material in the sample, and the distance from the detector to the sample.

The user may also select from a list of pre-defined ISOCS Shield Collimators, if using the Canberra ISOXSHLD, or enter his own shield's parameters. Both circular and rectangular shields and collimators can be used.

This data is then automatically combined with the data from the detector characterization to generate an efficiency calibration curve. This calibration, which is performed in a matter of seconds, can then be stored, used in any of our software platforms [Genie-PC, Genie 2000, Genie-ESP], and re-used just as if it had been produced by the traditional "custom source" method.

An additional benefit to this mathematical approach to calibration is the ability to easily play "What if?".

For example, a series of ISOCS calibrations can be performed, each with the same sample dimensions but different sample density parameters. By using each such calibration in turn to assay the spectrum from a single sample count you can easily determine the impact of various sample matrices on the results of the assay. This can be an invaluable tool when you need to determine the assay error bounds for large, difficult to characterize samples such as boxes, drums, floors, and walls.

Sample Types and Geometries

At the present time ISOCS comes with ten standard geometry templates. Each of these templates can be modified by the presence or absence of either of the collimator configurations included with the ISOCS shield assembly. Additional templates will be added as they are developed and, for applications with special requirements, custom templates can be provided.

The standard ISOCS geometries and typical applications for each are:

Simple Box

A basic rectangular carton or waste shipping container as shown in Figure 6; a truck filled with scrap iron, or even a small building.

Complex Box

The same as the Simple Box, but with a more complex sample matrix. It includes the ability to distribute the contamination across as many as four layers of material and/or to place an additional concentrated source anywhere in the container. Ideal for use in "What If?" analyses of non-uniform distribution in waste assay containers.

Simple Cylinder

A basic barrel, tank, or drum, as shown in Figure 7. In an emergency, it could also be used for a quick whole body contamination count.

Complex Cylinder

The same as the Simple Cylinder, but with a more complex sample matrix. It includes the ability to distribute the contamination across as many as four layers of material and to place an additional concentrated source anywhere in the container. Ideal for use in "What If?" analyses of non-uniformity in barrels and drums.

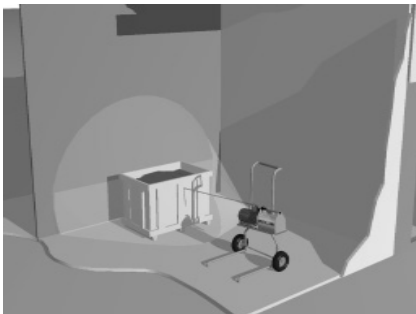

Figure 6
Waste Containers.

Pipe

A pipe, empty or full, including material that has plated out or built up on the inner walls, as shown in Figure 8.

Circular Plane

The end of a barrel or tank, the bottom of a bottle containing a sample, or a filter cartridge. This would also be used for *in situ* measurements of ground. The radioactivity can be distributed in any manner in up to ten layers of sources/absorbers.

Rectangular Plane

A floor, wall, or ceiling, or soil *in situ*, as shown in Figures 9 and 10. The template allows for surface contamination as well as up to ten layers of internal contamination behind an absorber such as paint, paneling, or a floor covering.

Well or Marinelli Beaker

Used for well logging applications, or for standard Marinelli beakers.

Sphere

Internally contaminated spherical objects, like large pipe valves.

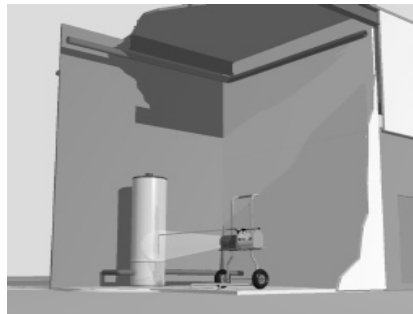

Figure 7
Tanks and Drums.

Exponential Circular Plane

For soils or neutron-activated concrete or other objects where the distribution of radioactivity can be described by an exponentially increasing then decreasing function.

Special templates additionally available:

- Surface contamination on I or H beam.
- Surface contamination on round tube/pipe/tank, inside or outside.
- Surface contamination on square tube/box inside or outside.
- Surface contamination on angle or L beam.
- Surface contamination on inside of room/box with detector in room.
- Volumetric contamination in partially filled horizontal pipe/tank.
- Volumetric contamination in partially filled conical tank.

Using ISOCS for *In Situ* Assays

To illustrate how ISOCS is used, several typical applications will be briefly discussed. The general procedure is the same for each, with the differences being in the type and number of physical sample parameters that must be measured.

The basic procedure is as follows:

1. The needed shield components, if any, are fitted to the detector.
2. The detector is aimed at the sample, using the built-in laser as a positioning aid.

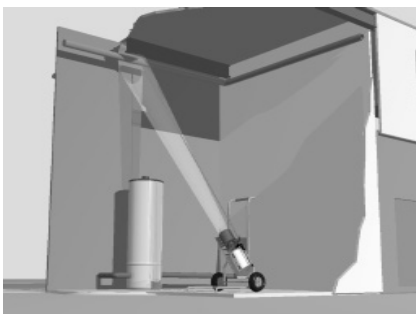

Figure 8
Pipes.

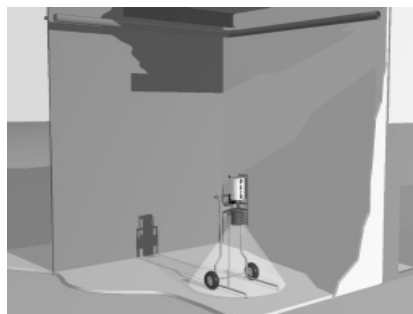

Figure 9
Soil or Floors.

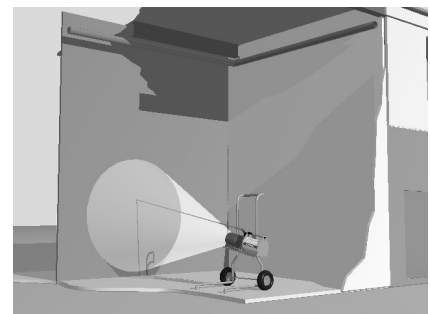

Figure 10
Walls.

3. A sample count is performed.
4. The necessary physical sample measurements are taken.
5. An ISOCS calibration is performed, using the appropriate geometry template and the sample measurements, as shown in Figure 11. This can be done during sample collection, if desired.
6. The spectrum collected in Step 3 is analyzed using the calibration results from Step 5.

In the sections which follow the specific steps required for several common sample types will be described.

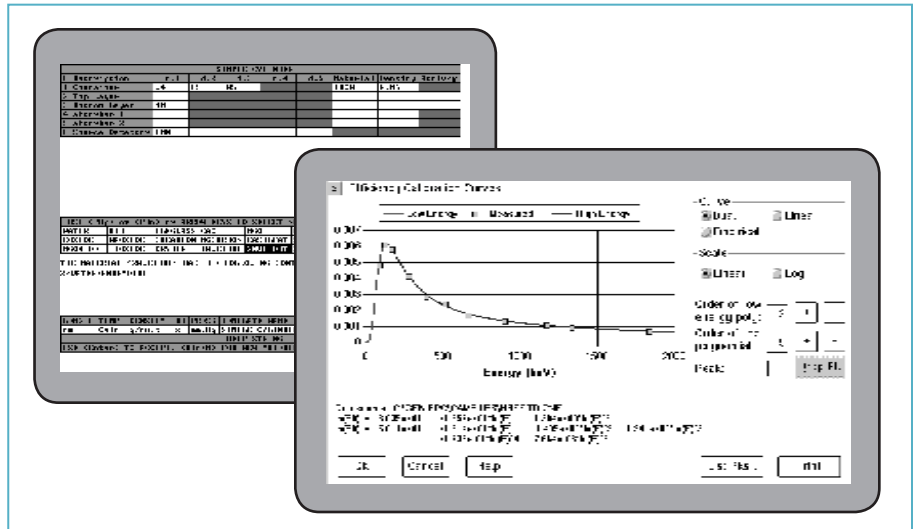

Figure 11
Using ISOCS for Efficiency Calibration.

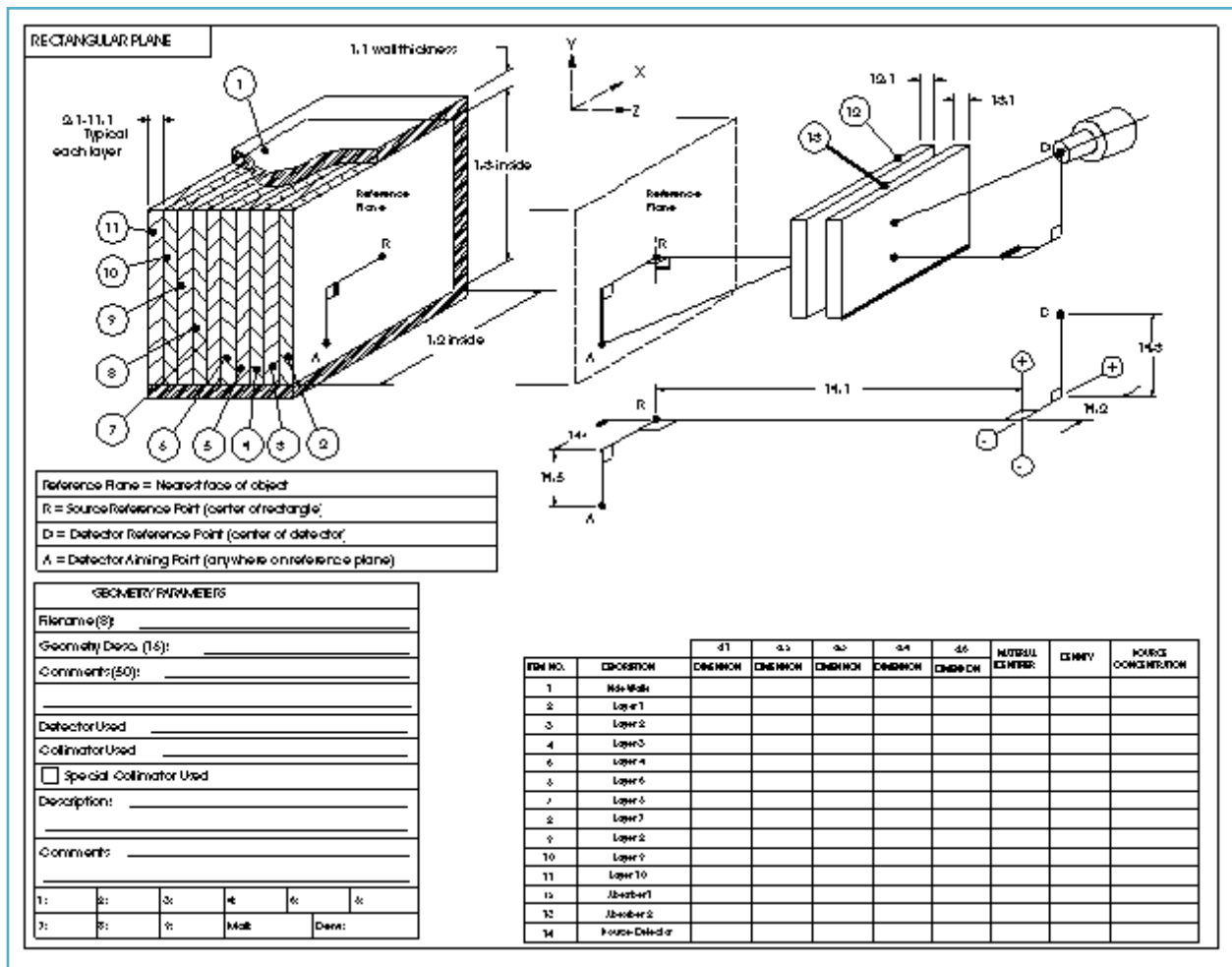

Figure 12
The geometry for a floor, wall, or ceiling.

Soil or Floor Assay

Since this is the most traditional of *in situ* assays, it will be used for the first example. These assays, as well as those for walls and ceilings, are normally based upon the Circular Plane or Rectangular Plane template shown in Figure 12. The procedure is as follows:

1. Fit any needed shield and collimator to the detector.
2. Position the detector vertically on its stand, looking downward at and perpendicular to the soil or floor.
3. Perform the count.
4. Measure and record:
 - a. The distance from the detector to the surface (Item 14.1 in Figure 12. If the detector is not perpendicular to the surface and not aimed at the center of the object, you need the other 14.2-5 measurements.)
 - b. The size of the section being assayed. (Items 1.2 and 1.3. If a general assay of a large open area is being done, just use a large value, like 20 m.)
 - c. If the contamination is under a surface such as in a paved parking lot, record the thickness, composition, and density. Each of the ten layers can be either sources or attenuators. For attenuators, enter 0 for the relative concentration.
 - d. The thickness, composition, density, and relative concentration of each radioactivity layer.

Once the count is complete, you have all of the data that is needed. You can go on to count the next sample and perform the assay later, or

complete it now if you wish. In either case, the process is:

5. Launch ISOCS Calibration, as shown in Figure 11.
6. Select the Detector and Collimator, if any, that were used when the count was made. When you do that, the appropriate physical parameters for those devices are automatically loaded.
7. Select the Rectangular Plane template and enter the physical data that was collected.
8. Do the calibration, and use it for the analysis of the sample spectrum.

In a few seconds you'll have the completed qualitative and quantitative results.

But what if...?

But what if there are several different contaminated layers of soil? Or a layer of asphalt on top of the concrete that is covering the contaminated soil? This is where the other parameters in the geometry template come into use.

Referring to Figure 12, items 2 through 11 represent ten different layers of material. For any or all of them you can enter a thickness (assumed or measured), the material, and density, and the relative concentration of each layer [absorbers have 0 concentration]. After entering the desired "What if...?" assumptions, re-run the ISOCS calibration, analyze the sample spectrum again, and you can immediately see the results of these new assumptions. This type of analysis can be used to define the boundary conditions for each measurement.

Assay of a Pipe

Next we'll take a look at the procedure used for the *in situ* assay of a contaminated pipe. The basic acquisition, calibration, and analysis process is essentially the same as the one for a soil count, with the differences related to the types of physical parameters that must be recorded.

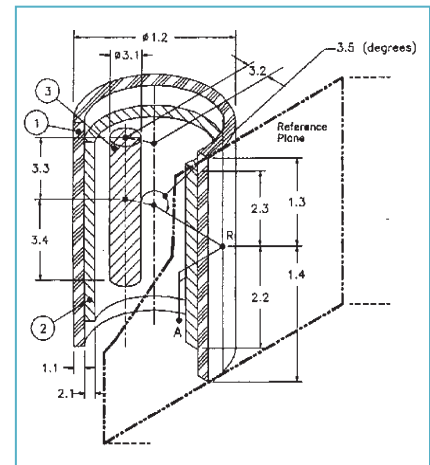

Figure 13
The geometry for a pipe.

Figure 13 shows the basic parameters of the Pipe template. These are:

1. The dimensions of the pipe, including the wall thickness, diameter, and the length on either side of the detector's aiming point, as indicated on the pipe by the built-in laser pointer.
2. The dimensions of any material that may have been plated onto the wall of the pipe.
3. The dimensions of any material that is contained in the pipe. Note item 3.2, which allows you to offset the center of this activity, treating it as a precipitate layer or partially filled pipe. Angle 3.5 allows this to be on the bottom portion of a horizontal pipe.

For all of three of these you can also specify a material and density. Like all of the ISOCS templates, it also includes the ability to specify up two layers of an absorber between the pipe and the detector and has a provision for entering the offset distances should it not be possible to have the detector perpendicular to the sample when the count is performed.

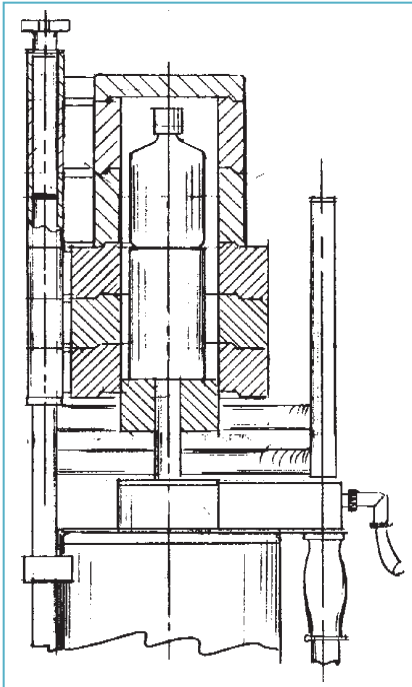

Figure 14

The ISOCS Detector and Shield set up for sample assay.

Traditional Sample Assay

The last example, shown in Figure 14, is the ISOCS detector and shield configured for counting a sample in a bottle or other similar container. You'll note that it combines both the 5 cm (2 inch) and 2.5 cm (1 inch) shield assemblies to yield a counting chamber that shields both the detector and the sample. The end cap at the top of the chamber is also part of the 2.5 cm shield kit. For counting dirt or liquid, just remove the collimator and top shield section. Place the dirt in a large Marinelli Beaker and put it over the top of the detector. The dirt/liquid is now both a sample and a shield.

The geometry template used for this application depends upon the shape and nature of the sample, with the Circular Plane template being the logical choice for bottles and filter cartridges. This template is identical to the Rectangular Plane template used for the Soil Analysis example except for its shape.

Complete details on this template, or any of the others currently supplied with ISOCS, can be found in the Model S573 *ISOCS Calibration Software* specification sheet.

Additional Information

Additional information on ISOCS, its hardware and software components, and its applications may be found in the following publications, all of which are available from us:

Specification Sheets

- Model ISOXSHLD ISOCS Shield System
- Model S573 ISOCS *In Situ* Calibration Software for Genie 2000
- Model 1300 InSpector 2000 DSP Portable MCA
- Model S500/S502/S504 Genie 2000 Basic Spectroscopy Software
- Model S501C Genie 2000 Gamma Analysis Software
- Model S505C Genie 2000 QA Software
- Model S506C Genie 2000 Interactive Peak Fit software
- Model S503 Genie 2000 PROcount Counting Procedure Software

Publications

Many papers have been written about *in situ* gamma spectroscopy, ISOCS, and mathematical calibrations of detectors. You can see many of them on the Mirion website at www.mirion.com.

Configuration and Ordering Information

A typical ISOCS system consists of the following items. Consult with us for additional configuration information, available options, and pricing.

Detector

SIZE: As appropriate for the job. For general purposes where mostly low level measurements are to be quickly performed, detectors between 30% and 60% relative efficiency are good choices. For maximum performance at low energies, choose the BEGe detector. For high activity source measurements, choose a small Coaxial or LEGe detector.

TYPE: Coaxial, BEGe, LEGe, REGe, or XtRa as appropriate.

DEWAR: Model 7935-2 MAC where size/weight is important, or Model 7935-5 Big MAC for maximum holding time (recommended).

RDC-4: Remote Detector Chamber option strongly recommended.

Detector Deployment Accessories

Model ISOXSHLD for the complete 25 mm and 50 mm set.

Model INSITPOD Lightweight Collapsible Tripod.

Spectroscopy Hardware

Model 1300 InSpector 2000 DSP Portable MCA.

Software

Model S501C Genie 2000 Gamma Analysis Option.

Model S504C Genie 2000 Basic Spectroscopy Software.

Model S505C Genie 2000 Quality Assurance.

Model S573 ISOCS *In Situ* Calibration Software for Genie 2000.

Model ISOXCAL detector characterization for new detector, or ISOXCAL1 detector characterization for existing Canberra detector, or ISOXCAL2 detector characterization for non-Canberra detector.

Computer

IBM or compatible Laptop, Windows 95/98/NT. If fast computations are important, get plenty of RAM and a fast processor.

Recommended Options

Model 702 Carrying Case for Detector, InSpector, PC, and D-2 fill device.

Model D-2 Portable detector LN filling device.

Model NTD-30 or NTD-50 LN withdrawal Device along with either D-30 or D-50 Storage Dewar.

Model 2324 ¹³⁷Cs and ⁶⁰Co uncalibrated QA daily field check source.

Model S506C Genie 2000 Interactive Peak Fit software.

Model SU-455-3IN Environmental *In situ* Measurements Using

the InSpector, three day course in Meriden for one person. On-site course are also available.

In Situ Gamma Spectroscopy Can Save You Both Time and Money.

In situ measurements will rarely be the complete solution, but for many cases it can greatly reduce the number and cost of gross [dose rate/countrate] field measurements, and number of samples for laboratory measurements. With ISOCS, these field measurements are now easy to do. ISOCS should be added to the selection of tools available for field and emergency measurements.

In situ measurements using Ge detectors do not address beta emitters and may not fully address low levels of alpha emitters. But, where other information is known (process knowledge, laboratory measurements of a few samples after radiochemistry, etc.) useful correlation ratios may be established and verified with gamma spectroscopy.

In the section which follows are some examples of where we believe having ISOCS as part of your radiological tool kit would be both useful and cost-effective. Is your application there? If it is, contact your local office to learn more about the time and cost savings offered by ISOCS.

Just a Few of the Many Applications That Can Benefit from ISOCS...

Environmental Monitoring Programs Around Nuclear Sites

- Measuring natural radioactivity when selecting new monitoring locations.
- Periodic measurements at fixed locations to identify long term trends or confirm the absence of long term low level deposition.
- Measurement of depositions at non-standard measurement locations to prove no unmonitored releases.
- Emergency response measurements:
 - Plume measurements with collimated detector aimed at sky.
 - Ground deposition measurements.
 - Field vegetation and water measurements.
 - Field gamma spectroscopy on air particulate and iodine cartridge samples.

Public Health Measurements

- Measurement of grounds and buildings of suspected contaminated areas. Immediate results feedback is better than lab data several months later.

Environmental Monitoring Around Accelerator Sites

- Background: Accelerators generate unusual activation products in air, soil, concrete, etc. They are commonly short half-life elements, so laboratory sample analysis is more difficult.
- Measurement of airborne plumes to identify nuclides.
- Measurement of soil and concrete to identify/quantify induced activity.



HP Measurements in Normally Operating Nuclear Facilities

- Check for total contamination (not just removable contamination). Aim collimated detector at suspect area (object, wall, ceiling).
- Check large areas for contamination (smears or hand probes just measure where the detector/smear is, if the contamination is not uniform, it could be missed). Aim collimated detector at suspect area (object, wall, ceiling).
- Check for unexpected contamination. A single measurement in center of room can prove that floors/walls/ceilings have not become contaminated, and that exposed sources are not in the room.
- Determine activity inside pipes/tanks without sampling. This could be easier and safer. And it could be more accurate if the sampling is not representative.
- Check for abnormal process operation. Take routine measurements at standard locations of piping, ventilation exhausts, etc. to monitor the rate of internal contamination buildup.

- Identification of nuclides present to confirm dose rate conversion factors [especially if using sensitive but non-linear gross counting probes] and appropriate protection response [radiotoxicity is dependent upon the radionuclide].
- Identification of nuclides present after abnormal gross/dose rate survey indication.
- *In vivo* measurements of thyroid activity. WBC measurements where higher detection levels are acceptable.

Environmental Remediation Measurements

- For surface or near-surface measurements, much less expensive than sampling and laboratory measurements.
- Field results allow new measurements to be taken immediately to fill in data gaps or to resolve questionable data.
- Multiple measurements on grid pattern can prove the absence of contamination and locate it if present. Detector heights determines spatial sensitivity. Large detector-ground separations measure larger areas with fewer measurements, or with better accuracy.
- Collimators can be used to reduce influence of adjacent sources or to define the spatial area of a measurement.
- For subsurface measurements, drilling holes and taking samples is very expensive. Instead, line the holes with plastic pipe, and take measurements at various depths down the hole.
- For measurement of sludge/mud at bottom of lakes/ivers, sampling is very difficult. Use Ge detector in waterproof housing (e.g. the Submarine waterproof detector housing).

Decontamination and Decommissioning of Buildings

- Preliminary scoping surveys to see if something is there or not. Unshielded detector in center of room is very sensitive to removable, fixed, and buried contamination.
- Evaluation of surface area contamination. Collimated detectors aimed at large wall/floor/ceiling areas can quickly prove that contamination is present/absent and to quantify it.
- Looking for buried contamination (or proving it to be absent). This could be contamination covered over by paint or new concrete layers, or in pipes hidden inside walls or under floors. Sampling will be very difficult, and is likely to miss contamination.
- Estimation of depth of contamination by looking at peak ratios. Where this is possible, this technique can be much more accurate and much less expensive than taking samples for laboratory analysis.
- To replace/reduce sampling and subsequent laboratory analysis:
 - Instead of slicing concrete cores and lab analyses, drill hole and insert detector (perhaps with side collimator for fine depth information).
 - Instead of scabbing off surface layers of concrete, place collimated detector over area.
 - Instead of drilling out samples of steel/concrete/etc. to look for neutron activation, place collimated detector over area.

Maintenance Operations in Nuclear Facilities

- Identify nuclides present and activity present inside valve/pipe/tank before opening. This is generally easier and safer and more accurate than sampling. Knowing the activity allows the proper amount of radiological protection to be applied. Too little *and* too much can likely increase the dose.
- Evaluate residual activity in tanks/pipes. Plateout is difficult to sample.
- Evaluate the depth of contamination by evaluation of energy line ratios.
- Estimate location of radioactivity in/on complex objects by use of multiple measurements from different angles.



Radioactive Waste Measurements at Generation Sites

- For the large user, automatic waste box/drum assay systems designed specifically for this task are available from us. For the small user, an *in situ* system can be used for drums and boxes, although the count times may be longer and more labor would be required.
- For unusual shaped objects that do not fit into standard waste assay systems, use the *in situ* system.
- Perform periodic measurements with nuclide specific results, to verify that the waste stream characterization is as expected. This is important of other instruments that are not nuclide specific (dose rate, gross counting) are used to generate shipping and disposal records.

Radioactive Waste Measurements at Disposal Sites

- Shippers commonly estimate activity, and generally estimate high because it is conservative. However this “excess” radioactivity could fill up a disposal site too early.



- Periodic verification of shippers declared activity. Test a few random containers. Measurement of the entire container is more accurate than taking samples of non-homogeneous waste. For large numbers of measurements, consider the Mirion Box Counter (just a large number of shielded *in situ* measurements).
- Field inspections of waste generator activities.

Tool kit for Routine and Emergency Response for Radiological Health Authorities

- Quick field response to transportation accidents. Has anything spilled? What is it? How much is it? Where do we take samples? Is any quick action required?
 - Rapid response from alarms on scrap steel monitors (sample taking is very difficult). What is it? How much is it?
 - Rapid response from alarms on gross counters at country border inspection points. What is it? How much is it?
 - Independent verification of users' environmental monitoring program via ground deposition measurements, and independent sample measurements.
- Measurement of short lived nuclides in environmental samples or effluents from hospitals, accelerators, reactors, etc.
 - Independent verification of users laboratory measurement program (more rapid response than lab measurements, makes short lived nuclide measurements possible).
 - Portable gamma spectroscopy laboratory-in-a-box, when combined with portable shield Quantitative measurements can be performed on air particulate samples, gas samples, iodine samples, water samples, vegetation samples, dirt samples, etc.
 - Emergency and/or very portable *in vivo* counter. Take to hospitals to measure injured contaminated people. Can be used for higher level measurements where too much radioactivity prevents normal WBC use. Thyroid measurements in universities or hospitals. Retained activity in nuclear medicine tests. Count groups of people at one time to prove that contamination not present as emergency response triage tool.
 - *In vivo* measurements of thyroid activity. WBC measurements where higher detection levels are acceptable.

