

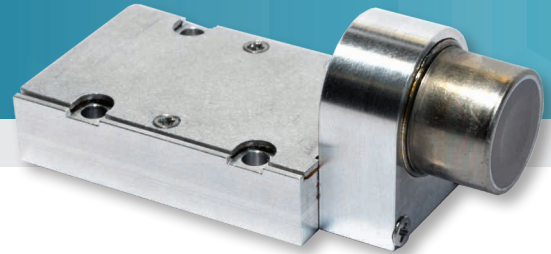

SXD30M-500-PA

X-PIPS™ Detector (SDD)



KEY FEATURES

Detector System Includes:

- Silicon Drift Detector (SDD)
- Be Window
- Low noise FET
- Low Power Peltier Cooler

PERFORMANCE

- Active Area – 45 mm²
- Collimated Active Area – 30 mm²
- Thickness – 0.5 mm
- Typical Resolution – 135 eV (FWHM)*
- Energy Range – 1 to 30 keV
- ΔT>75K at 30 °C heat sink temperature

DESCRIPTION

The X-PIPS Detector is a spectroscopy sub-system sensitive to X-rays and low-energy gamma rays. It comprises a hermetically sealed silicon drift detector (SDD) element with a low noise FET assembly and Peltier cooler. The detector element and FET preamplifier are cooled. The Beryllium entrance window is standard 0.5 mil.

The preamplifier has a reset mechanism providing fast reset time and excellent count rate performance.

The energy resolution is guaranteed at typical operating temperature within an ambient temperature range of +10 °C to +30 °C.

The X-PIPS Detector has an internal multilayer collimator for improved peak to background.

Model	Active Area (mm ²)	Collimator	PTB		Energy Resolution FWHM (eV)*	
			Typical	Min	Typical	Max
					@ Optimum Rise Time	
SXD30M-500-PA	30	Multilayer	15000	>12000	<135	<145

* Energy resolution is given at 5.9 keV (Mn-Kα), with an ambient temperature ranging from +10 °C to +30 °C, on a digital spectroscopy system with trapezoid shaping filter. Cooled at typical operating temperature of -35°, maximal cooling at room temperature is -55 °C.

X-PIPS Detector (SDD) SXD30M-500-PA

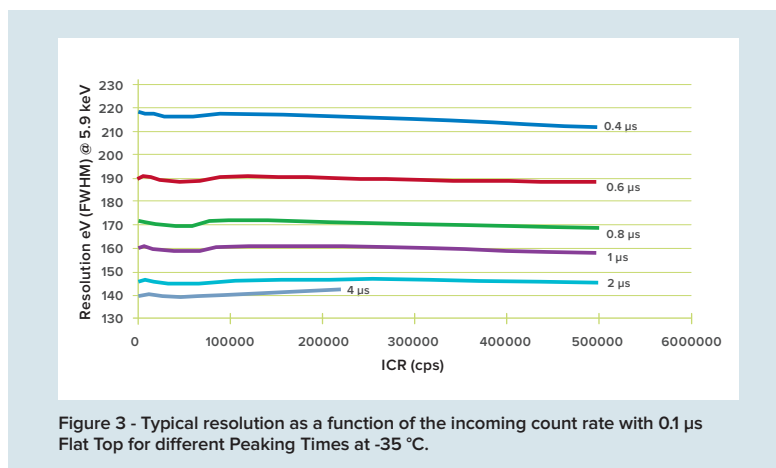
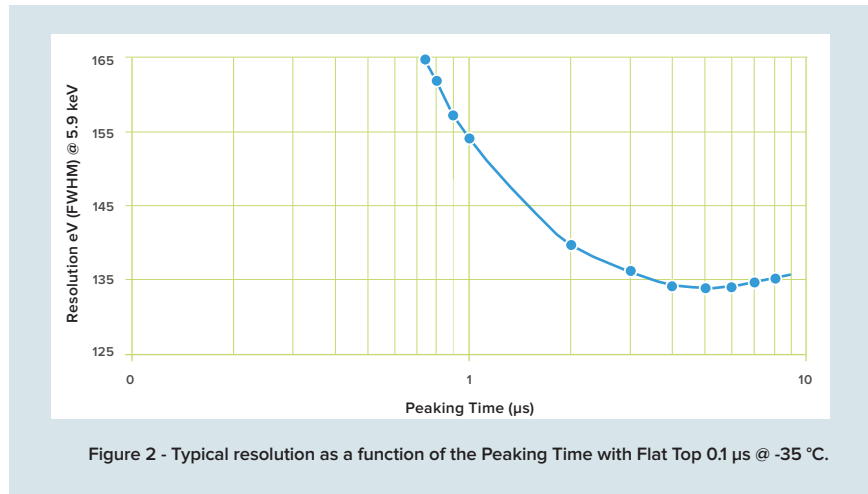
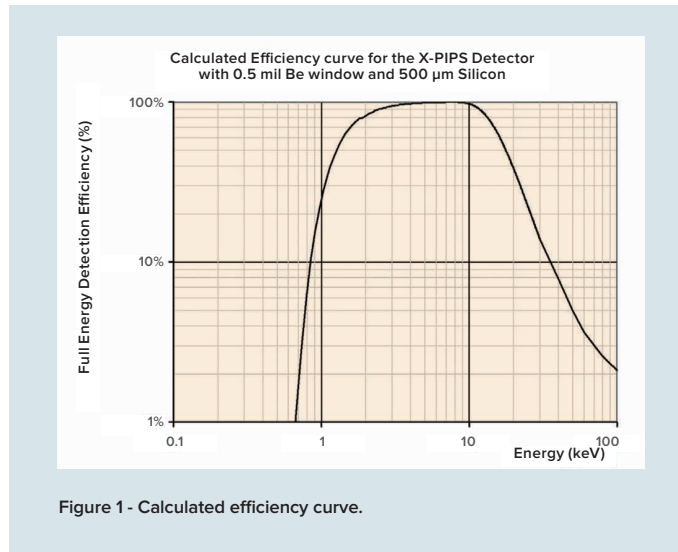

SPECIFICATIONS

PERFORMANCE

GAIN STABILITY

- <25 ppm/°C over a range of +10 °C to +30 °C.
- <50 ppm over 24 h at constant temperature with 1 h stabilization.

CHARGE SENSITIVITY

- Gain is 3 mV/keV.
- Gain tolerance is ±25%.

PHYSICAL

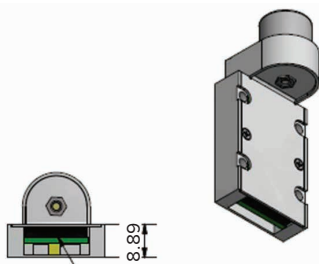
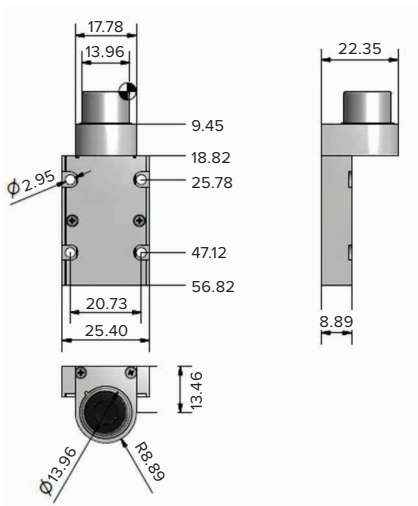

Connector: 10 position FFC/FPC 1 mm pitch

POWER REQUIREMENTS

The connector on the preamplifier is a 10 position, 1 mm pitch FFC/FPC right angle connector (FCI part number SFW10R-2STE1LF). The pinout of the preamp (connector is on topside of the board, left to right) is:

1	TEC -
2	TEC +
3	+5 V
4	-5 V
5	Temp. GND
6	Signal Out
7	Temp. Diode
8	GND
9	No Connect
10	HV

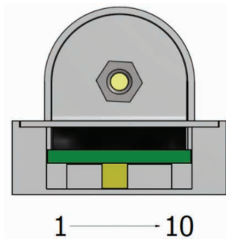

THE PREAMP REQUIRES TWO POWER SUPPLIES

- +5 V (nominal 15 mA, average 12 mA). Absolute maximum voltage is 6.3 V.
- -5 V (nominal 15 mA, average 10 mA). Absolute maximum voltage is -6.3 V.
- HV – -225 V (recommended).

TEMP READOUT

- Use connections Temp. Diode and Temp. GND.
- Temp. Diode (Bias) – 45 µA.
- SLOPE – -2.183 mV/°C
- V (0 °C) – 636 mV.

COOLER CONTROL

- MAX VOLTAGE – 3.6 V.
- MAX CURRENT – 0.4 A.

HEAT SINK

It is advisable to mount the detector housing to a heat sink in order to guarantee good dissipation of the heat generated by the Peltier cooler.

OUTPUTS

- GAIN – 3 mV/keV ±25%.
- DYNAMIC RANGE – -2.5V to 2.5V.

ENVIRONMENTAL

- OPERATING TEMPERATURE – 0 to 50 °C (32 to 122 °F).
- OPERATING HUMIDITY – 0 to 80%, non-condensing.

ORDERING INFORMATION

- SXD30M-500-PA.



©2016 Mirion Technologies (Canberra), Inc. All rights reserved.

Copyright ©2016 Mirion Technologies, Inc. or its affiliates. All rights reserved. Mirion, the Mirion logo, and other trade names of Mirion products listed herein are registered trademarks or trademarks of Mirion Technologies, Inc. or its affiliates in the United States and other countries. Third party trademarks mentioned are the property of their respective owners.

CANBERRA